



Cyprus
University of
Technology

EEN320 - Power Systems I (Συστήματα Ισχύος Ι)

Part 1: Introduction

<https://sps.cut.ac.cy/courses/een320/>

Dr Petros Aristidou

Department of Electrical Engineering, Computer Engineering & Informatics

Last updated: January 14, 2025

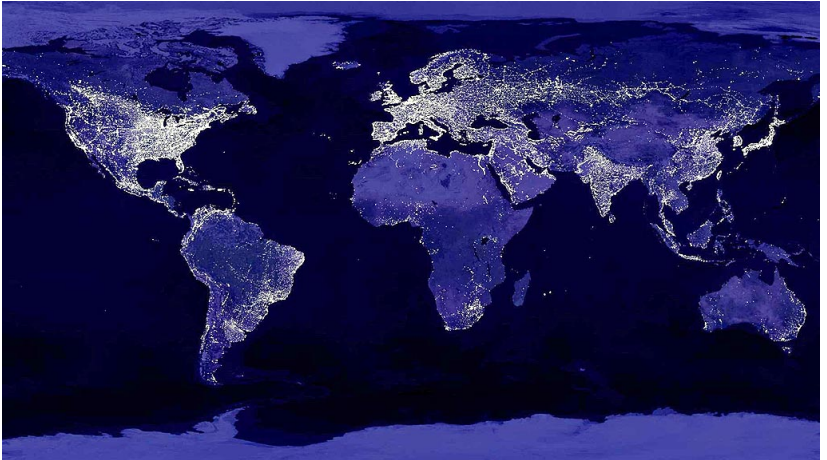

What is their purpose?

- 1 Transfer electric energy from point A to point B
- 2 Do it safely (don't kill anyone)
- 3 Do it reliably (continuous supply, no interruptions)
- 4 Do it environmentally friendly
- 5 Do it at a low cost and accessible to all

(3) - U.S. Northeast Blackout 2003

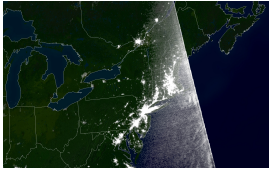

NYC before blackout, ©Nat. Oceanic and Atmospheric Admin.

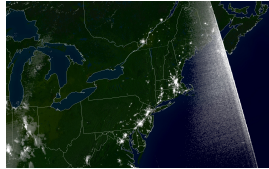

NYC after blackout, ©Nat. Oceanic and Atmospheric Admin.

- The outage on Aug, 14 2003 affected about 10 mio. people in Ontario, Canada and 45 mio. in the Northeastern and Midwestern United States
- Estimated cost: US\$ 4 to 10 billion
- A power plant in Eastlake, Ohio switched offline during high electrical demand
- This put a strain on high-voltage power lines, which later switched out of service when they came in contact with trees
- The resulting cascading effect ultimately forced the shutdown of more than 100 power plants



Italy and Switzerland after blackout, ©Reuters

- Outage on Sept, 28 2003 struck mainland Italy and parts of Switzerland affecting 56 mio. people
- The power line supplying electricity to Italy from Switzerland was damaged by storms and switched off
- Two 400 kV power lines between France and Italy switched off due to sudden increased demand
- Cascading effect disrupted power supply to Italy from France and Switzerland, control of the grid was lost in the next 4 seconds and lines tripped one by one



Norwegian Pearl, ©Pink Dispatcher

- The outage on Nov, 4 2006 affected 15 mio. households in parts of Germany, France, Italy, Belgium, Spain and Portugal
- Triggered by badly assessed switching off a transmission line over river Ems to allow safe passage of a cruise ship
- Further automatic switching off of transmission lines split the European transmission grid into three independent parts (West, North-East, South-East) leading to power imbalances in each area
- The power imbalance in the Western area lead to a large frequency drop causing outages for consumers

- According to the UCTE report on the disturbance
 - The imbalance between supply and demand as a result of the splitting was further increased in the first moment due to a significant amount of tripped generation connected to the distribution grid
 - Generally, the uncontrolled operation of distributed generation (mainly wind and combined-heat-and-power) during the disturbance complicated the process of re-establishing normal system conditions
- These statements also show that smarter control methods for distributed generation could contribute to system stability

(3) - A bit closer to home

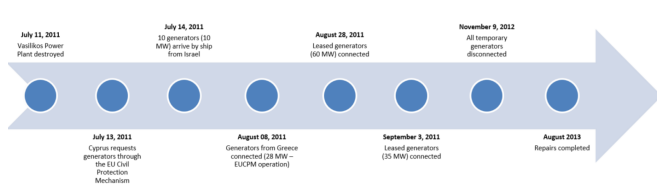

Karagiannis, et al. "Power grid recovery after natural hazard impact", tech. rep., 2017

- The Cyprus outage of 2011 affected all of the population on the island, leading to reduced supply and scheduled outages over a prolonged period of time
- Triggered by an explosion at Evangelos Florakis Naval Base that destroyed the Vasilikos Power Plant
- Almost 60% of the island's power generating capacity was destroyed
- Estimated economic losses from power interruption¹ around 840 million euros per year

¹T. Zachariadis, A. Poullikkas, The costs of power outages: A case study from Cyprus, Energy Policy, 2012

(4) - Environmental aspects

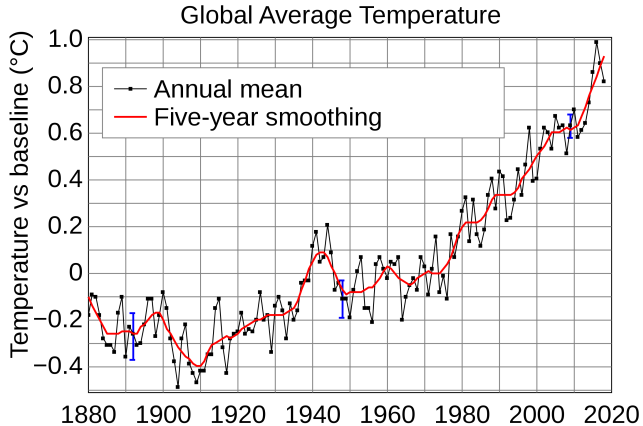

(4) - Two major problems with fossil fuels



- 1) Energy generation from fossil fuels highly contributes to greenhouse gas emissions & climate change!
- 2) Fossil fuels are finite!

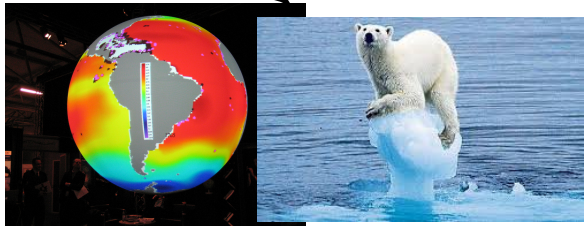

(5) - Cost of energy and development

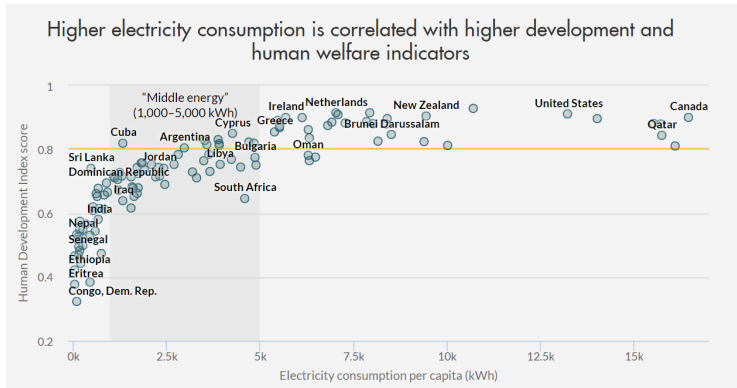

Source: UNDP Human Development Index (2013); World Bank, World Development Index (2013)

- Human Development Index: statistic composite index of life expectancy, education, and per capita income indicators
- First part of the curve almost linear!

(5) - Cost of energy and development

Number of people without access to electricity

The definition used in international statistics adopts a very low cutoff for what it means to 'have access to electricity'. It is defined as having an electricity source that can provide very basic lighting, and charge a phone or power a radio for 4 hours per day.

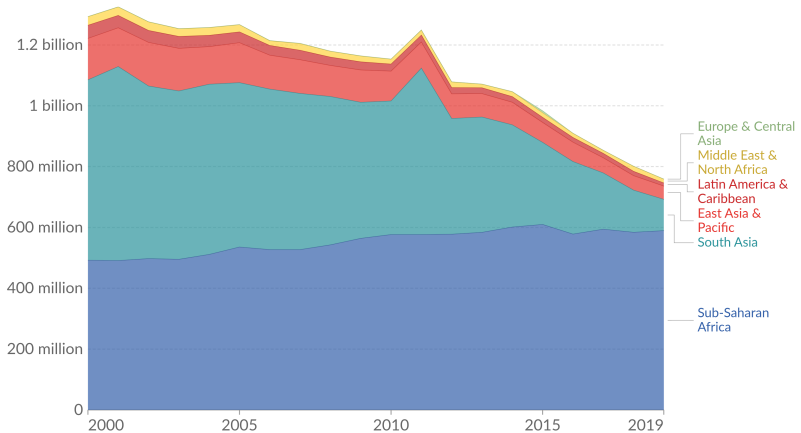

Source: Calculated by Our World in Data based on data published by the World Bank

OurWorldInData.org/energy • CC BY

Why is it hard to do all 5?

- World's largest and most complex engineered systems
 - Modern industrialized societies heavily rely on use and steady supply of electric energy
 - Power systems are expected to be very reliable
 - Even a single failure can have catastrophic consequences for society!
 - In addition: power systems continuously subjected to large variety of disturbances and contingencies (lighting, hurricanes, human errors, . . .)
- Rather complex and sophisticated industrial processes behind electric energy supply!



Onshore wind



Solar power



Offshore wind

Shift energy production
from fossil to
renewable energy sources



Marine power



Bioenergy



Small hydro
power

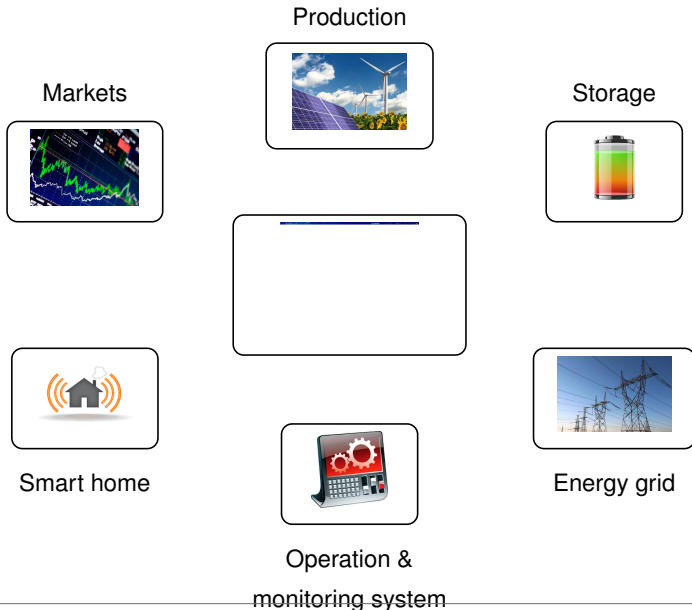

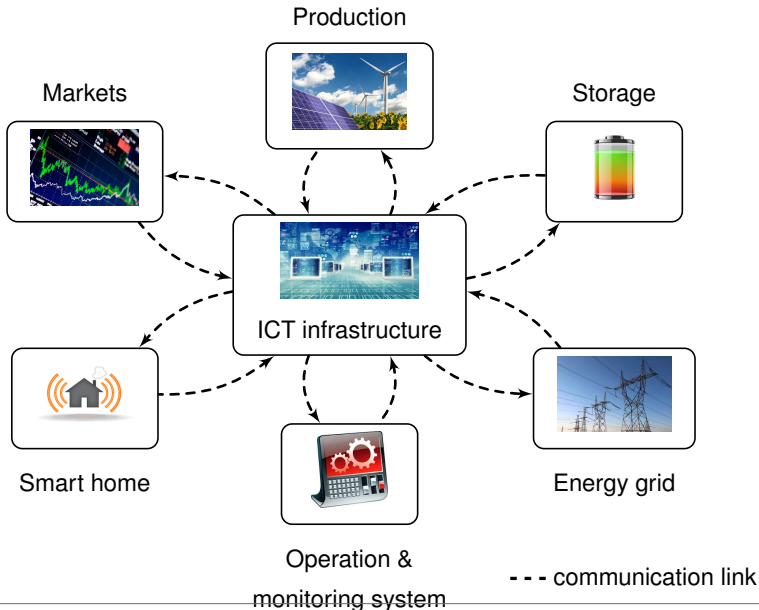

- Key ingredients: ICT, renewables, flexible operation & consumption
 - Many challenging open questions
 - Large investments (EU-wide 500 billion euros by around 2020)
- ⇒ Plenty of exciting & interdisciplinary opportunities

This course intends to provide you with a fundamental understanding of the key equipment and their functionality in power systems, so that you are well-prepared to further explore these opportunities

- 1 **EEN320 - course description**
- 2 **Electric energy**
- 3 **Generation of electric energy**
 - Power plants
 - Generation mix and capacity
- 4 **Transmission and distribution of electric energy**
 - Voltage levels and network types
 - Interconnected power systems
 - Network topologies
 - Substations
 - System operation and monitoring
- 5 **Consumption of electric energy**

- 1 EEN320 - course description**
- 2 Electric energy
- 3 Generation of electric energy
- 4 Transmission and distribution of electric energy
- 5 Consumption of electric energy

This course intends to provide you with a fundamental understanding of the key equipment and their functionality in electric power systems.

On completion of this course, you should be able to . . .

- 1 . . . explain the functioning and modelling of the main components in a power system
- 2 . . . understand the principles of planning and operation of power systems
- 3 . . . be able to solve basic load flow calculations
- 4 . . . have an overview of future trends in power systems and smart grids
- 5 . . . appreciate, through basic case studies, the technical challenges in both the design and the operation of power systems

- 1 Introduction
- 2 Single-phase and three-phase AC systems
- 3 The per-phase and per-unit system representation
- 4 The power transformer
- 5 Introduction to rotating machines
- 6 Synchronous machine
- 7 Induction machine
- 8 The transmission line characteristics

- Organization (subject to changes based on in-semester progress)
 - Wednesday 08:30-10:30 and Thursday 08:30-10:30
 - 26h theory, 10h example classes, 12h laboratory², 4h revision
- Assessment
 - Final exam: 60%
 - Mid-term exam: 20%
 - Lab exam: 20%
- Course site: <https://sps.cut.ac.cy/courses/een320/> and Moodle.

²might change based on in-semester progress

This course and its presentation are based on

- ① D. Glover, M. S. Sarma and T. Overbye, “Power System Analysis & Design”, 6th edition, Cengage Learning, 2017
- ② Chapman, S.J., “Electric machinery fundamentals”, 4th edition McGraw-Hill, 2005
- ③ Κ. Βουρνάς, Γ. Κονταξής, “Εισαγωγή στα συστήματα ηλεκτρικής ενέργειας”, εκδόσεις ΣΥΜΜΕΤΡΙΑ, 2010

Book 1 (available at the library) and the lecture notes are the official study material. Book 3 is alternative in Greek version.

- 1 EEN320 - course description
- 2 Electric energy**
- 3 Generation of electric energy
- 4 Transmission and distribution of electric energy
- 5 Consumption of electric energy

What is a kWh?

$$kWh = \frac{\text{Watt} \cdot \text{time}(\text{hrs})}{1000}$$

- Unit of measurement of energy

$$1 kWh = 1000 W \cdot 3600 s$$

$$1 kWh = 3600000 J$$

$$1 kWh = 3.6 \cdot 10^6 J$$

What does 1 kWh mean for your home?

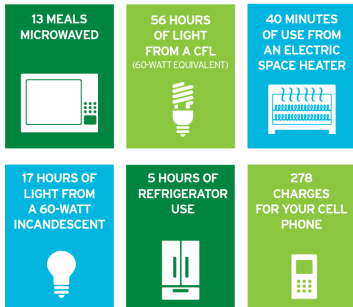

Source: <https://www.encyvermont.com/>

2 Change in energy demand

Primary energy consumption by world region

Primary energy¹ consumption is measured in terawatt-hours², using the substitution method³.

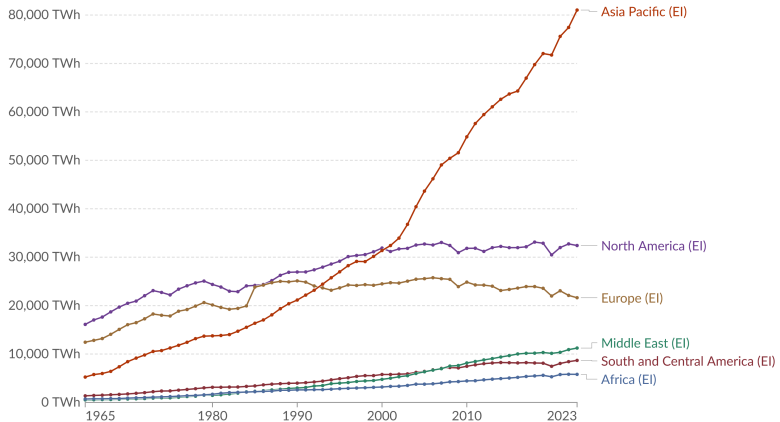

Data source: Energy Institute - Statistical Review of World Energy (2024)

OurWorldinData.org/energy | CC BY

2 Energy consumption by source

Global direct primary energy consumption

Energy consumption is measured in terawatt-hours, in terms of direct primary energy. This means that fossil fuels include the energy lost due to inefficiencies in energy production.

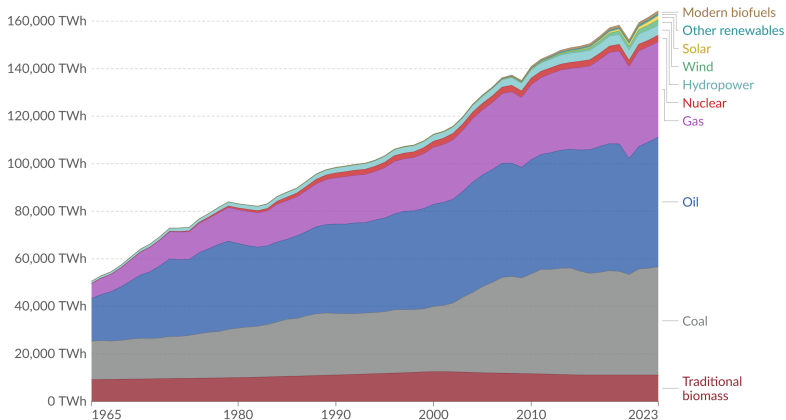

Data source: Energy Institute - Statistical Review of World Energy (2024); Smil (2017)

Note: In the absence of more recent data, traditional biomass is assumed constant since 2015.

OurWorldinData.org/energy | CC BY

2 Energy consumption by source

Primary energy consumption by source, 2023

Our World
in Data

Primary energy is based on the substitution method and measured in terawatt-hours.

■ Coal ■ Oil ■ Gas ■ Nuclear ■ Hydropower ■ Wind ■ Solar ■ Other renewables

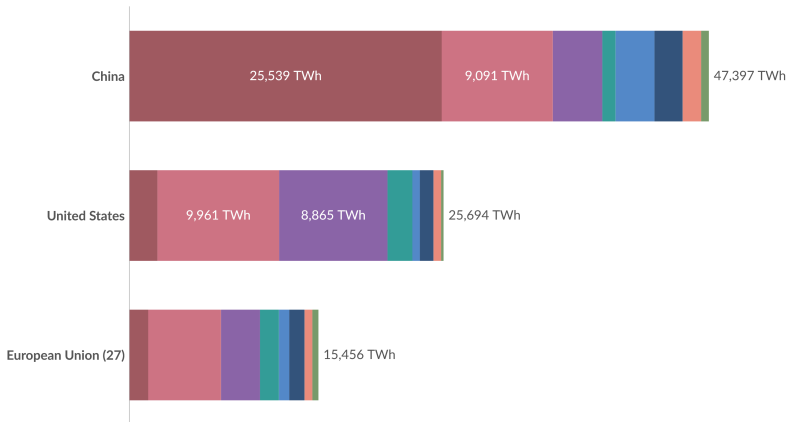

Data source: Energy Institute - Statistical Review of World Energy (2024)

OurWorldinData.org/energy | CC BY

2 Energy consumption by source

Primary energy consumption by source, 2023

Our World
in Data

Primary energy is based on the substitution method and measured in terawatt-hours.

Coal Oil Gas Nuclear Hydropower Wind Solar Other renewables

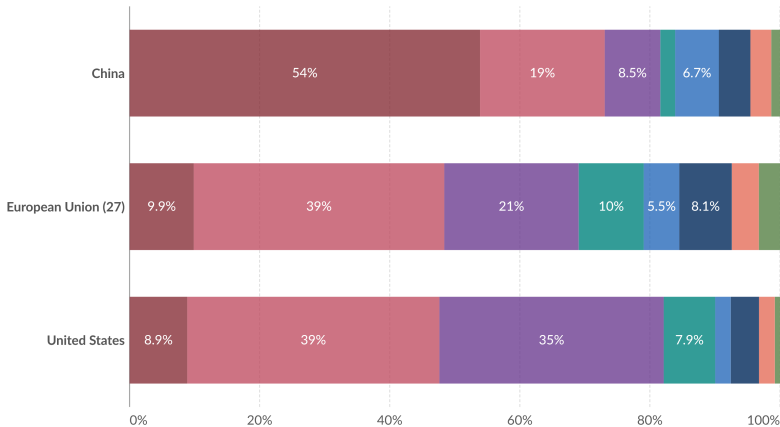

Data source: Energy Institute - Statistical Review of World Energy (2024)

OurWorldinData.org/energy | CC BY

2 Energy consumption by source

Energy consumption by source, Cyprus

Measured in terms of primary energy using the substitution method.

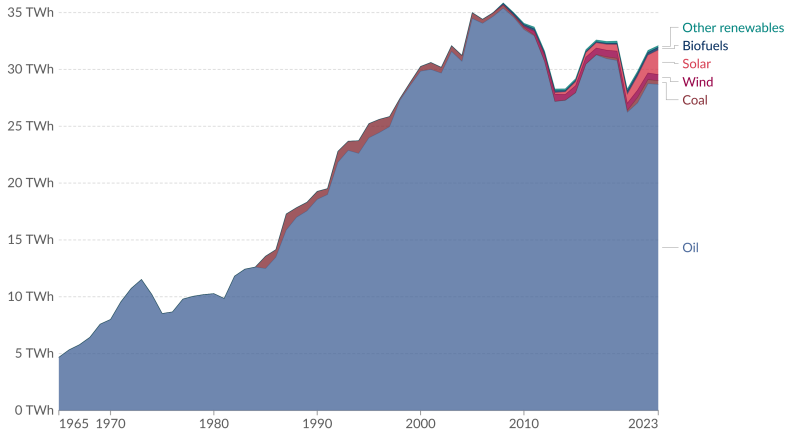

Data source: Energy Institute - Statistical Review of World Energy (2024)

Note: "Other renewables" include geothermal, biomass, and waste energy.

OurWorldinData.org/energy | CC BY

2 Energy consumption by source

Energy consumption by source, Cyprus

Measured in terms of primary energy using the substitution method.

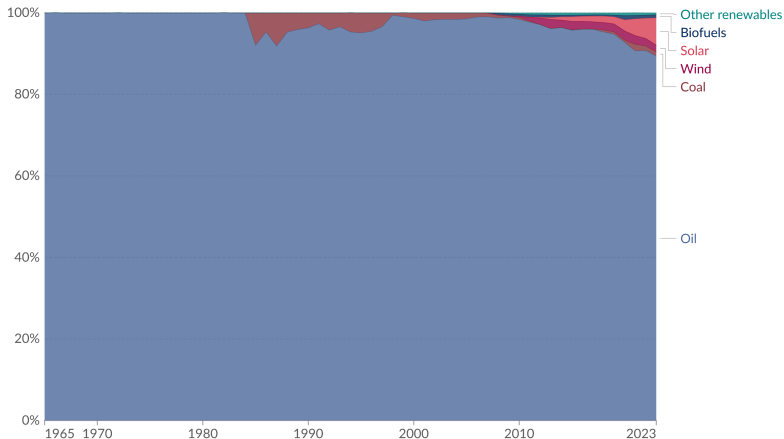

Data source: Energy Institute - Statistical Review of World Energy (2024)

OurWorldinData.org/energy | CC BY

Note: "Other renewables" include geothermal, biomass, and waste energy.

- Advantages
 - can be used for a variety of purposes
 - can be converted efficiently from different primary sources
 - can be converted to mechanical or thermal energy with a high efficiency
 - can be transmitted and distributed with reasonably low losses
 - easy to measure and control
- Disadvantages
 - difficult to store
 - danger of handling high-voltages

2 Electric power system overview

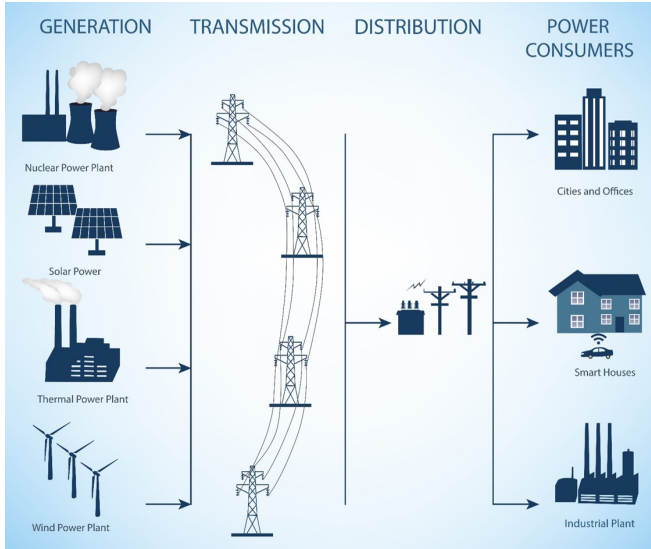

- 1 EEN320 - course description
- 2 Electric energy
- 3 Generation of electric energy**
 - Power plants
 - Generation mix and capacity
- 4 Transmission and distribution of electric energy
- 5 Consumption of electric energy

- Electric energy is obtained by converting primary energy into electric energy
- Strictly speaking, energy can not be generated nor consumed
- Yet we often say that electricity is being "generated", meaning that a primary energy source is converted into electric energy
- This process of energy generation (i.e., conversion) takes place in power plants

Fossil (non-renewable) energy sources

- Oil, gas, coal,...
- Cannot be replaced on a timespan of human significance
- Limited and can eventually run out



Renewable energy sources

- Sun, wind, biomass, tides,...
- Are replaced by natural processes at a rate comparable to their use
- Unlimited



3 Sources of electric energy - Fossils and renewables

Electricity production from fossil fuels, nuclear and renewables, World

Measured in terawatt-hours.

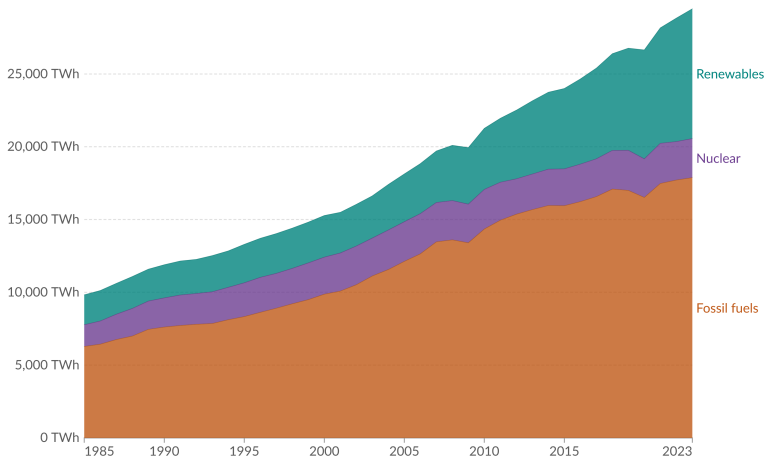

Data source: Ember (2024); Energy Institute - Statistical Review of World Energy (2024)

OurWorldinData.org/energy | CC BY

3 Sources of electric energy - Fossils and renewables



Electricity production from fossil fuels, nuclear and renewables, European Union (27)

Measured in terawatt-hours.

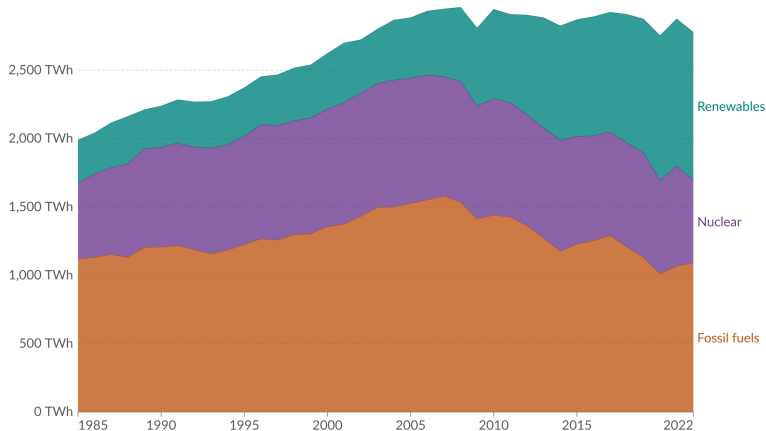

Data source: Ember (2024); Energy Institute - Statistical Review of World Energy (2024)

OurWorldinData.org/energy | CC BY

3 Sources of electric energy - Fossils and renewables



Electricity production from fossil fuels, nuclear and renewables, Cyprus

Measured in terawatt-hours.

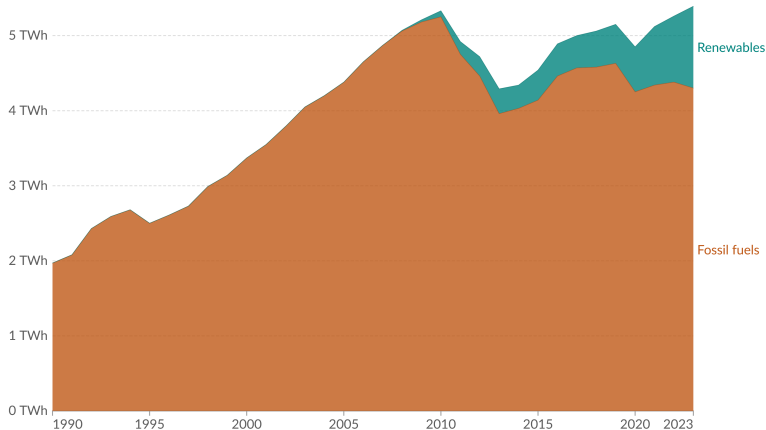

Data source: Ember (2024); Energy Institute - Statistical Review of World Energy (2024)

OurWorldinData.org/energy | CC BY

3 Electric energy VS total

More than one-third of global electricity comes from low-carbon sources; but a lot less of total energy does

Our World in Data

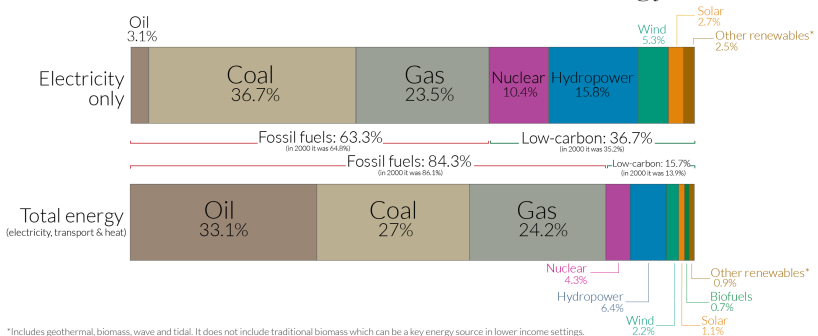

*Includes geothermal, biomass, wave and tidal. It does not include traditional biomass which can be a key energy source in lower income settings.

OurWorldinData.org - Research and data to make progress against the world's largest problems.

Source: Our World in Data based on BP Statistical Review of World Energy (2020). Based on the primary energy and electricity mix in 2019.

Licensed under CC-BY by the author Hannah Ritchie.

- Traditional technologies
 - **Steam power plant:** thermal energy of steam expanded in steam turbine; steam production mainly via fossil (coal, oil) or nuclear (uranium) primary sources
 - **Gas turbine generation:** kinetic energy obtained from burning fuel directly to create high-pressure gas used to drive turbine; mostly natural gas (methane) used as primary energy source; turbines similar to those used in aircraft
 - Steam and gas turbine generation jointly referred to as thermal generation
 - **Hydro power plant:** potential and kinetic energy of water is used to generate electricity via turbines
- **Renewable energy technologies**
 - Wind power plants
 - Solar power plants
 - Biomass-based power plants
 - ...

3.1 Power plant technologies - Steam power plant (1)

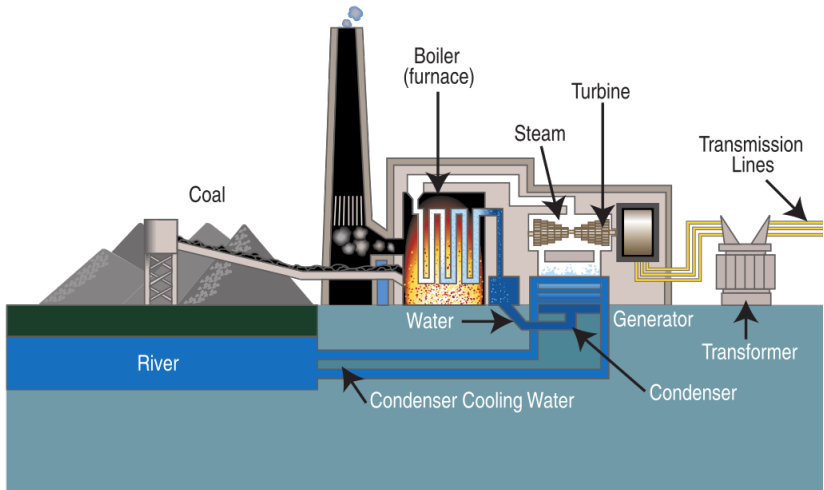

©Tennessee Valley Authority

- Combustion of coal or gas creates high-temperature (up to 600°) and high-pressure (up to 280 bar) steam based on Rankine cycle
- In nuclear power stations, nuclear fission used to create heat
- That steam is passed through steam turbines; usually turbines with several nozzles at different pressure levels (high, medium, low) → pressure-compounded turbine
- Exhaust steam cooled down in condenser
- Turbine shaft connected to synchronous generator to convert mechanical energy into electric energy
- Efficiency 38-47%
- Efficiency can be increased up to 60% through combined-heat-and-power (CHP) plants
- Very high power rating up to several 1000 MW

- Steam power plants are less flexible, compared to hydro power plants
- Need to operate within certain maximum temperature gradients
- Large time constants for variation in power output
- Also, operation mostly economic within certain operating regions
- Steam power plants usually used as *base load*



©Dave Pickersgill

- Coal-fired power station in North Yorkshire (also capable of co-firing biomass and petcoke)
- Generating capacity of 3,960 MW (highest in UK)

3.1 Power plant technologies - Steam turbine rotor



©Siemens

- Based on gas turbine cycle: burn fuel (natural gas) in compressed air, similarly to aircraft engines
- Comparable efficiency to steam power plants
- Advantage: can use gas-turbine exhaust to produce steam in conventional boiler to drive additional steam turbine
- Combined-cycle-gas turbine (CCGT) with improved efficiency around 60%
- Fast start-up and shut-down (2-3min for gas turbine)
- Often used for peak load supply

Σταθμός Βασιλικού	
3 x 130 MW Ατμοηλεκτρικές Μονάδες	390 MW
1 x 38 MW Αεριοστρόβιλος	38 MW
2 x 220 MW Μονάδες Συνδυασμένου Κύκλου	440 MW
Σταθμός Δεκέλειας	
6 x 60 MW Ατμοηλεκτρικές Μονάδες	360 MW
2 x 50 MW Μηχανές Εσωτερικής Καύσης	100 MW
Σταθμός Μονής	
4 x 37,5 MW Αεριοστρόβιλοι	150 MW
Συνολική Εγκατεστημένη Ισχύς	1478 MW

Source: <https://www.eac.com.cy/EL/EAC/Operations/pages/generation.aspx>

3.1 Power plant technologies - Hydro power plant (1)

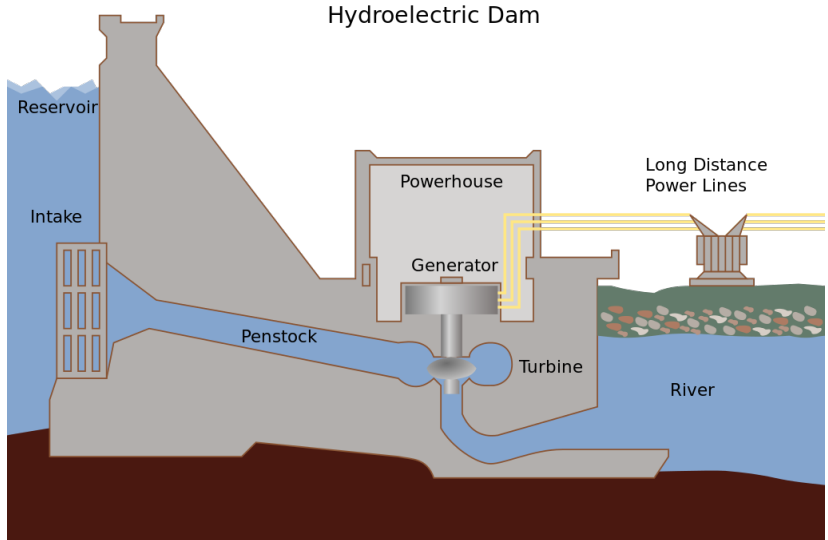

©Tomia

- Potential and kinetic energy of water in rivers and water reservoirs is converted to electric energy by using turbines
- Head = difference in height between upper reservoir and outflow level of turbine
- Different turbines used for different heads: Pelton (heads of 150 - 1500m), Francis (50 - 500m), Kaplan (run-of-river stations, heads up to 60m)
- Rule-of-thumb for generated active power

$$P \approx 8QH \quad [\text{kW}]$$

- Q : flow rate through turbine [m^3/s]
- H : head [m]
- Above expression includes efficiencies of hydraulic system, turbine and generator $\eta \approx 0.82 [10^3 \text{ kg}/(\text{m}^2\text{s}^2)]$

- Perhaps oldest form of energy conversion
 - Have ability to start up quickly (as little as 3 min.)
 - Have no energy losses when stand still
- Often used to supply (fast-varying) peak demand
- Challenge: need appropriate geographical conditions (that are difficult to find in Cyprus)
 - Low running costs (water is free), but rather high capital cost of construction

3.1 Power plant technologies - Hydro power plant (4)



©Le Grand Portage

- Three Gorges Dam on the Yangtze River, China
- Largest hydro power plant in the world with rated power of 22,500 MW

- Use kinetic energy of wind to produce electricity
- Maximum theoretically achievable active power

$$P_{\text{Betz}} = \eta_{\text{Betz}} \frac{1}{2} A \rho v^3$$

- Active power proportional to third power of wind speed v^3 [m/s]
- A : imaginary rotor surface [m^2]
- ρ : air density [kg/m^3]
- $\eta_{\text{Betz}} = 0.593$: Betz constant
- Practically achievable active power lower; modern plants achieve 70-80% of P_{Betz} at rated wind speed
- Often several wind turbines gathered in a wind park



Enercon E70, ©Hadhuey

- Wind power generation fluctuates with wind speed variation
 - Often, on-shore higher fluctuations than off-shore; also, typically higher wind speeds off-shore
- (Fairly) recent trend: off-shore wind farms
- Typical power rating: on-shore 2-5 MW, off-shore 4.6 - 8 MW per turbine



©Ad Meskens

- Solar energy can be either used directly or indirectly to generate electricity
 - Direct approach: Photovoltaics; conversion of solar energy into DC current; efficiency approx. 12-20%
 - Indirect approach: Concentrated solar power power plants; use solar energy to generate heat or steam to drive a turbine; efficiencies of up to 42%



©Koza1983



©Andrewglaser

3.1 Power plant technologies - Renewables

Share of electricity production from renewables

Renewables includes electricity production from hydropower, solar, wind, biomass, and waste, geothermal, wave and tidal sources.

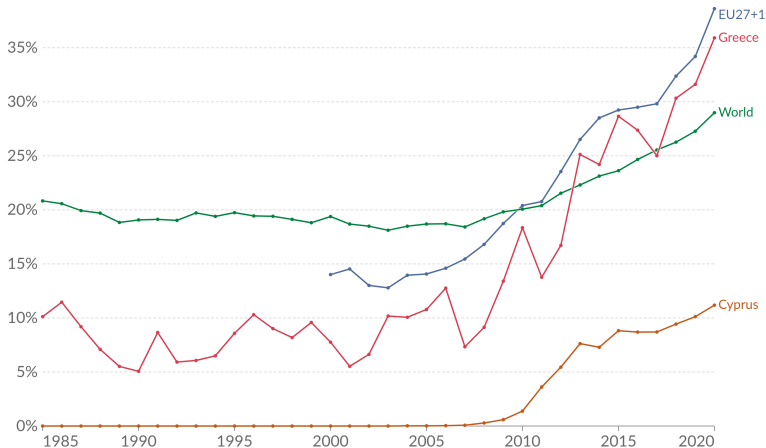

Source: Our World in Data based on BP Statistical Review of World Energy & Ember (2021)

OurWorldInData.org/energy • CC BY

Modern renewable energy generation by source, Cyprus

Measured in terawatt-hours.

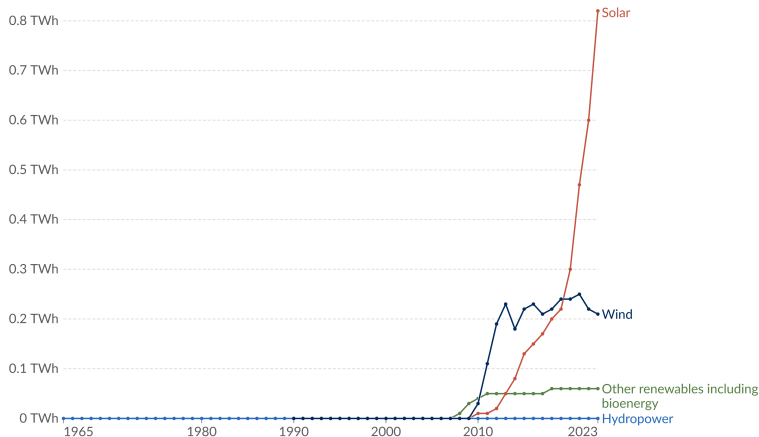

Data source: Ember (2024); Energy Institute - Statistical Review of World Energy (2024)
OurWorldinData.org/renewable-energy | CC BY

- Fuel cells
- Geothermal power
- Wave power
- Tidal power
- ...

- Generation costs are composed of
 - Investment costs (e.g. plant construction)
 - Operating costs (e.g. for fuel)
- ⇒ Optimal technology depends on its specific purpose(s)
- Usual differentiation of generation technologies
 - Base-generation
 - Mid-merit generation
 - Peak-load generation

- Base-generation (φορτίο βάσης)
 - High capital and low per unit operating costs
 - Run-time > 5000 h/y
 - Example: nuclear, hydro, lignite
- Mid-merit generation (μέσο φορτίο)
 - Medium capital and medium per unit operating costs
 - Run-time > 4000 h/y
 - Example: coal
- Peak-load generation (φορτίο αιχμής)
 - Low capital and high per unit operating costs
 - Run-time < 1000 h/y
 - Example: gas, pump storage

3.2 Generation mix and capacity - Example

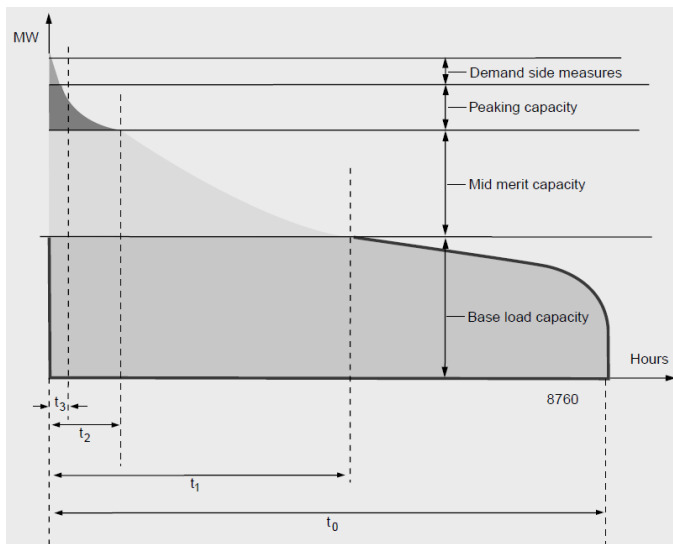

- t_0 base load run-time
- t_1 mid-merit run-time
- t_2 peak-load run-time
- t_3 time period of load curtailment

Source: Weedy et al., Electric Power Systems

3.2 Generation mix and capacity - Cyprus

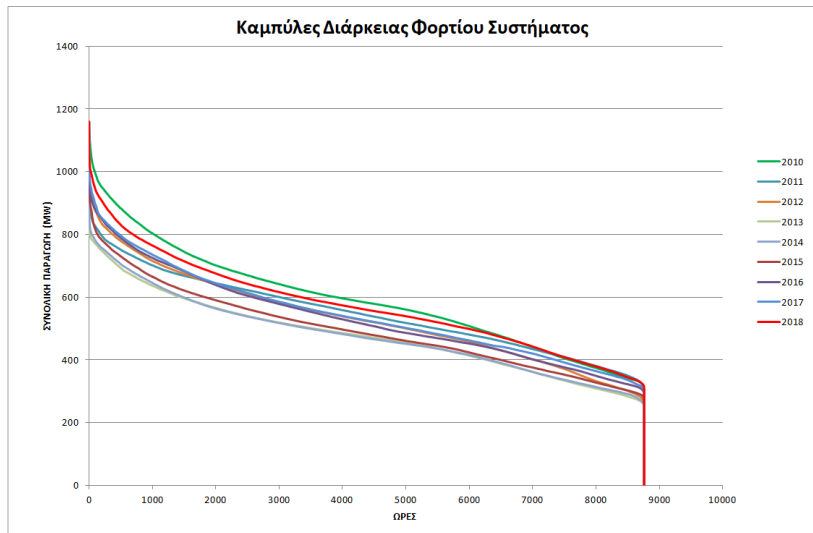

Source: <https://www.dsm.org.cy/>

- 1 EEN320 - course description
- 2 Electric energy
- 3 Generation of electric energy
- 4 Transmission and distribution of electric energy**
 - Voltage levels and network types
 - Interconnected power systems
 - Network topologies
 - Substations
 - System operation and monitoring
- 5 Consumption of electric energy

4 Electric power system overview

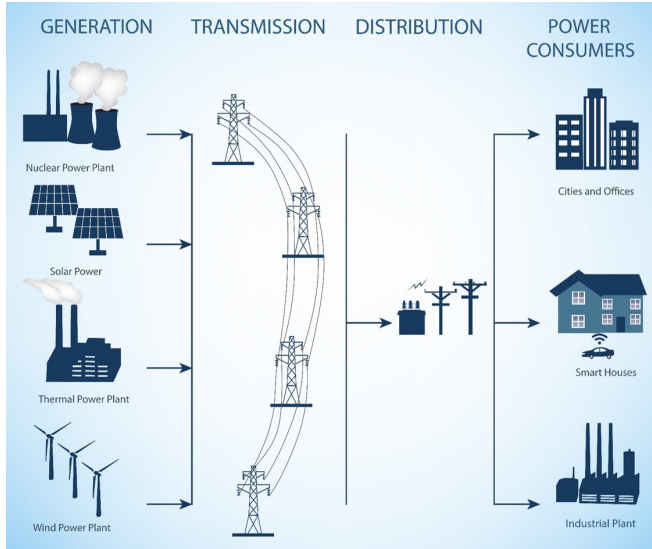

- Often, economic, geographic, environmental or technological reasons impede generation of *all* demand closed to load centres (cities, industrial sites)
- Therefore, large share of electric power is generated far away from load centres
- Need (electric) infrastructure to transport electricity from generators to loads
- This infrastructure is called a power network

- Optimal economic interconnection of different generators / end-users / networks mainly depends on
 - Distance
 - Amount of power to be transmitted
- Consequently, most power systems worldwide consist of
 - **Transmission network:** *global* power network over large distances; works at high voltages
 - **Distribution network:** *local* electricity network to deliver power to end-users; works at medium and low voltage
 - Voltage usually transformed several times to lower values the closer to end-user
 - These voltage transformations are performed in **substations**
 - Above low voltage (LV) level, power transfer is usually three-phase

4.1 Electric power systems - Standard structure (1)

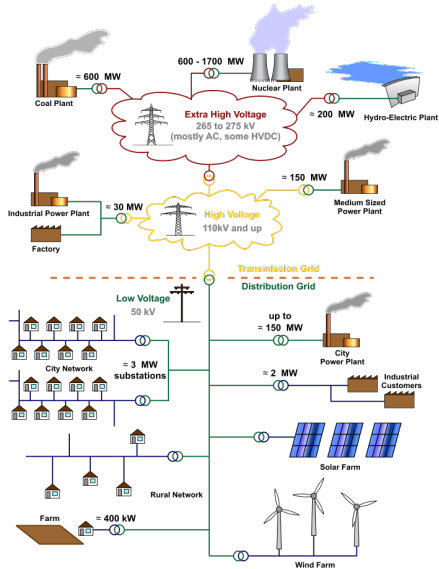

©MBizon

4.1 Electric power systems - Standard structure (2)

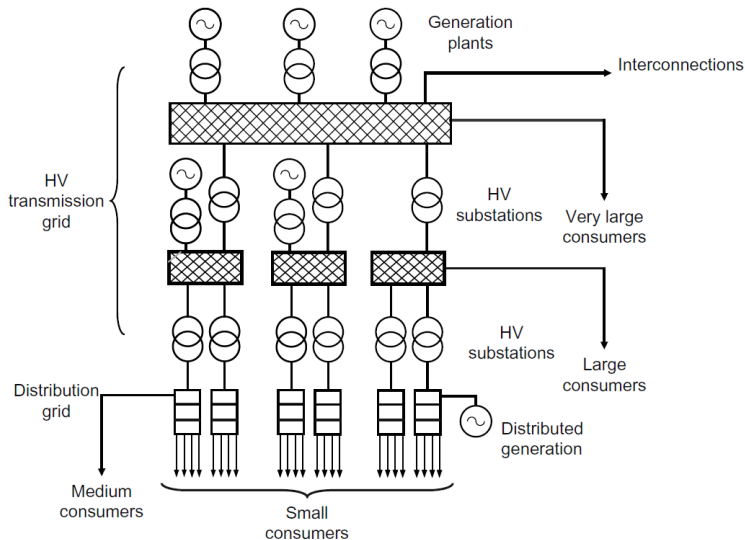

Source: J. Machowski et al, "Power system dynamics: stability and control", John Wiley & Sons, 2011

4.1 Early history of electric power systems

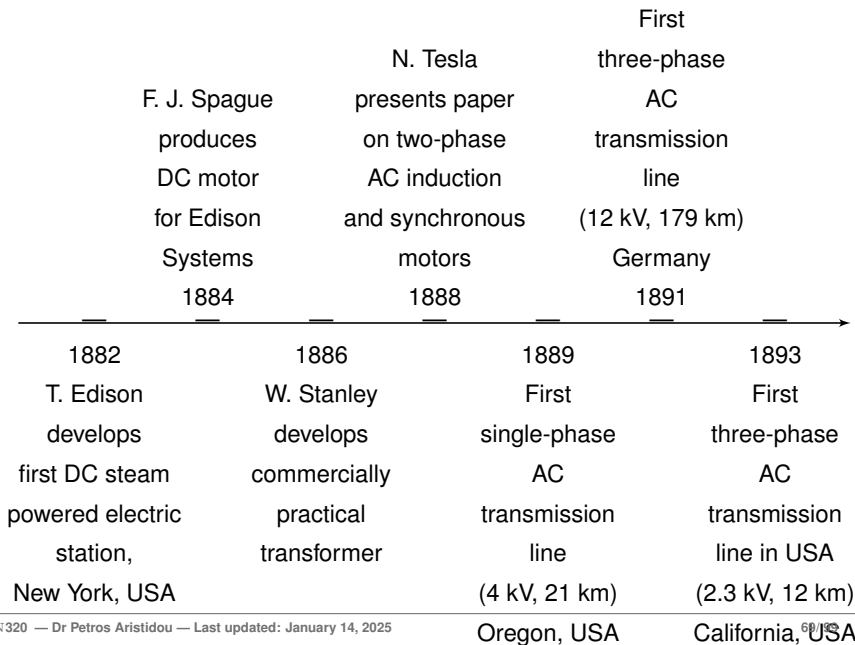

- 1878: T. Edison began work on electric light and designed concept of central power station serving lighting in its neighbourhood
- Opening of Pearl Street Station (DC, 30 kW, 110 V, lighting for 59 customers, 2.5 m^2 area) marks beginning of electric utility industry
- Beginning of fast growth of electric utility industry until today
- Development of transformer alleviated voltage issues encountered with longer transmission lines
- War of currents: Edison promoted direct current (DC), while Westinghouse (US entrepreneur and engineer) promoted alternating current (AC)
- Change of voltage levels via transformers and circuit breakers exploiting zero-crossings, along with Tesla's AC motors pushed AC systems

4.1 Early history of electric power systems

- Tesla came to the correct conclusion that motors operated most efficiently at 60 Hz and 240 volts
- Edison admitted the superiority of AC and built his own systems running the lines at 110 volts (adopting the same voltage used in his DC systems)
- When the German company AEG built the first European generating facility, its engineers decided to fix the frequency at 50 Hz, because the number 60 didn't fit the metric standard unit sequence (1, 2, 5)
- AEG had a virtual monopoly and its standard spread to the rest of the continent
- But the order imposed by the metric system was at odds with physics. Not only is 50 Hz 20% less effective in generation, it is 10–15% less efficient in transmission and it requires up to 30% larger windings and magnetic core materials in transformer construction
- Today only a handful of countries (Antigua, Guyana, Peru, the Philippines, South Korea and the Leeward Islands) follow Tesla's advice and use the 60 Hz frequency together with a voltage of 220–240

Source: J. Christopher Westland, *Global Innovation Management*, 2ed, Red Globe Press, 2016

- 1903: First generators to serve the needs of the Commission and the general hospital in Lefkosia
- 1912: First generation company in Lemesos – Electrofotistiki Eteria Lemesou (The Limassol Electric Light Company)
- 1913: Nicosia Electricity Company
- 1922: Municipal Electricity Authorities of Ammochostos, Larnaka and Pafos
- 1927: Municipal Electricity Authority of Kyrenia
- 1952: Electricity Authority of Cyprus merged 28 companies serving 6 major towns and 22 smaller townships and villages (total 28)
- 1972: Full electrification of the island (527 towns and villages). From 20,000 consumers in 1952 to 180,000 in 1973 and 576,000 in 2018

Source: <https://www.eac.com.cy/>

Globally:

- From 1890 to 1975 electric energy consumption raised in average 7% in industrialised nations
- This is equivalent to doubling the energy demand every 10 years!
- Likewise, size of generation units increased
- Main incentive: *economy of scale*
 - Lower installation costs per kW
 - Lower operating costs per kWh

Country	high voltage (HV)	medium voltage (MV)	low voltage (LV)
UK	400 kV (275 kV)	132 kV - 11 kV	400 / 230 V
Germany	380 kV	110 - 10 kV	400 / 230 V
US	765 - 345 kV	230 - 4 kV	480 / 120 V
Nigeria	330 - 132 kV	33-10 kV	415/240 V
Cyprus	132 - 66 kV	22-11 kV	400/230 V

- The above voltage magnitudes refer to the line-to-line voltage V_{LL} of the corresponding three-phase system
- The line-to-ground voltage V_{LG} is given by $V_{LL} = \sqrt{3}V_{LG}$

4.1 Example of Cyprus

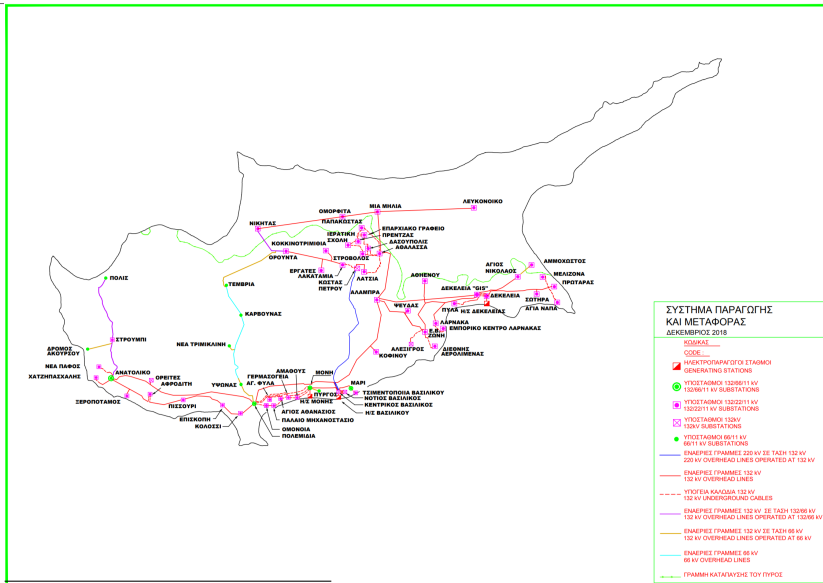

Source: <https://www.dsm.org.cy/>

- Interconnection of power systems has advantages in reliability and economy
 - Power support in emergencies
 - Cross-border power transfers and trading
 - Fundamental prerequisite for international electricity market
- Two power systems can be coupled via
 - Synchronously = AC connection (e.g., continental Europe)
 - Asynchronously = DC connection (e.g., UK)

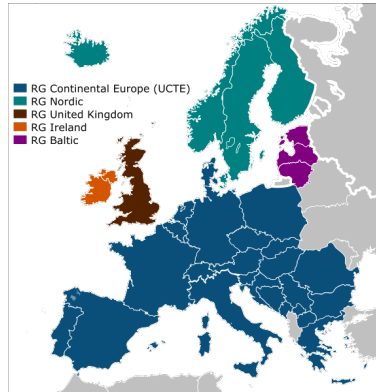

Synchronous grids in Europe, ©Kimdime

4.2 Interconnected power systems - ENTSO-E



Source: ENTSO-E

- European Network of Transmission System Operators for Electricity (ENTSO-E)
- 41 transmission system operators
- 34 countries, 450 mio. people
- 1,000 GW generation capacity

4.2 Commercial electricity flows in Europe May-July 2014 [GWh]

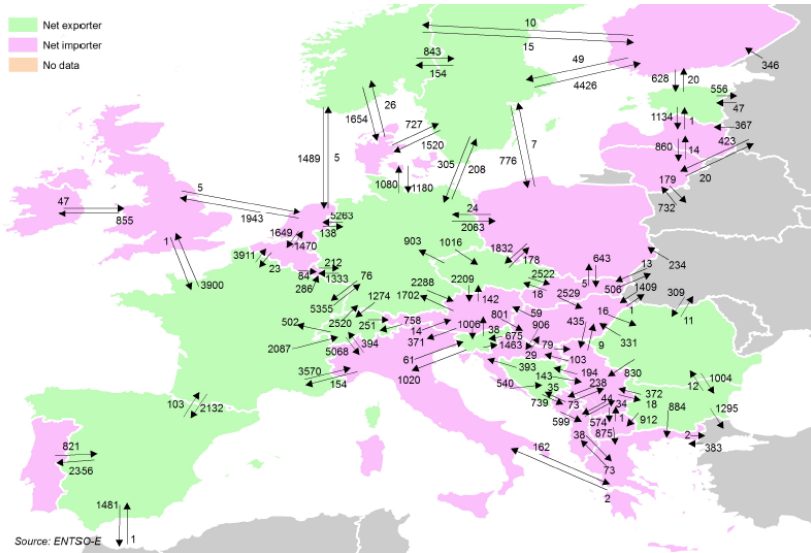

Source: European Commission, Quarterly Report on European Electricity Markets

4.2 Interconnected power systems - China

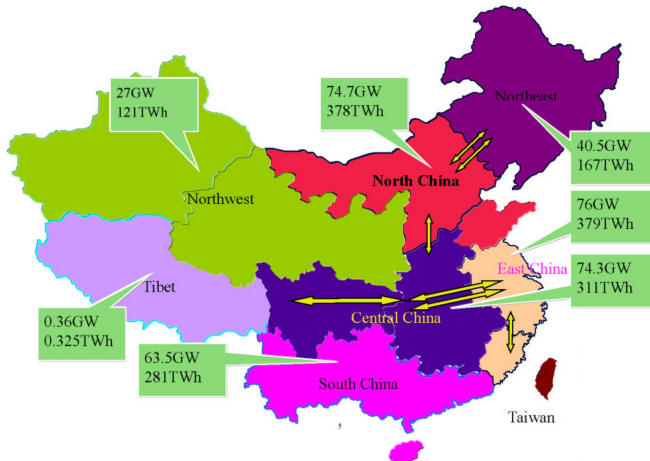

- 2 transmission system operators: State Grid Corporation & China Southern Power Grid
- > 360 GW generation capacity

Source: www.geni.org

4.2 Interconnected power systems - China

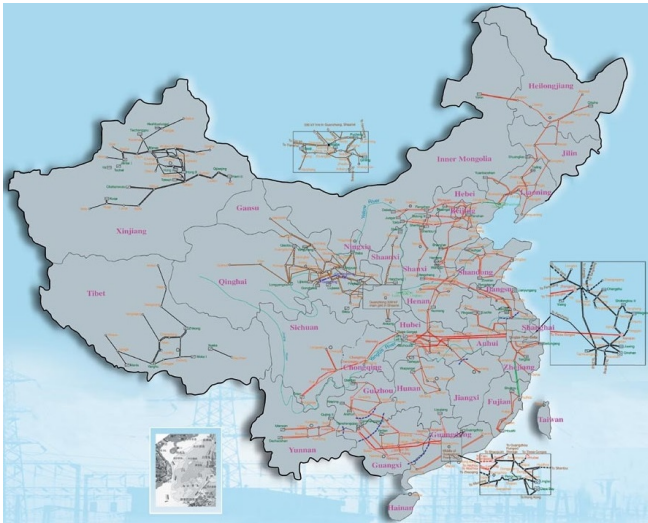

- 2 transmission system operators: State Grid Corporation & China Southern Power Grid
- > 360 GW generation capacity

Source: www.geni.org

4.2 Interconnected power systems - WAPP



- West African Power Pool (WAPP)
- 14 countries

4.2 Interconnected power systems - NERC

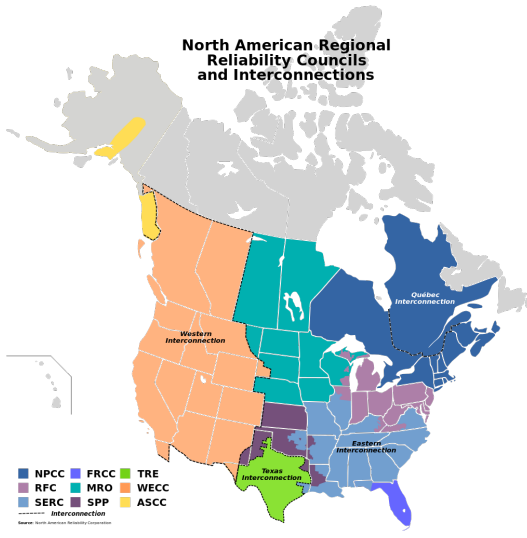

©Bouchecl

- North American Electric Reliability Corporation (NERC)
- 8 regional reliability entities
- > 1,000GW installed capacity

- Simple point-to-point connections are not suitable to provide *reliable* power supply, as a single line failure leads to blackout
- Need network topology, where power can be transmitted over alternative path if a power line fails
- This creates redundancy and, hence, increases reliability
- Most common criterion to define redundancy of a power network is *(N-1) criterion*

- After loss of one single element (e.g. line, transformer, power station)
 - ① Network must be able to continue service
 - ② No network element is overloaded
- (N-1) criterion is standard security criterion worldwide for power system planning and operation
- Defines network redundancy with respect to equipment outages
- Higher security indices: (N-2), (N-3),...

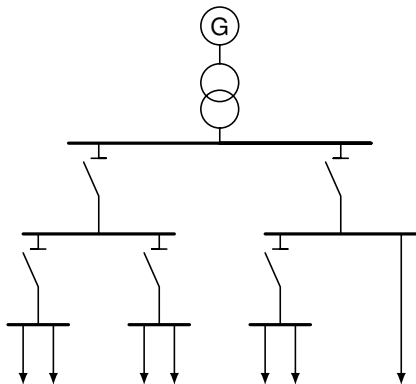

- Several independent network branches
- Often used in rural areas
- Overhead lines or cables (depends on country and load density)
- Advantages
 - Simple operation
 - Low investment costs
 - Easy to analyse and predict
- Disadvantages
 - Voltage sags at branch ends by high loading
 - Simple failures can lead to blackouts for end-users (not N-1 secure)

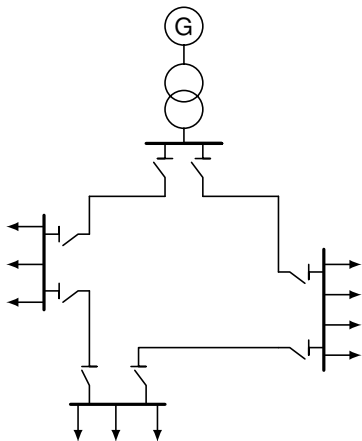

- Equipment rated such that operation can be maintained also if fault on ring occurs
- Often has circuit breaker in middle of ring
- Advantages
 - Higher reliability against failures ("quasi" N-1 security)
- Disadvantages
 - Higher costs: larger conductor, such that all loads can be fed from one end
 - Slightly higher complexity

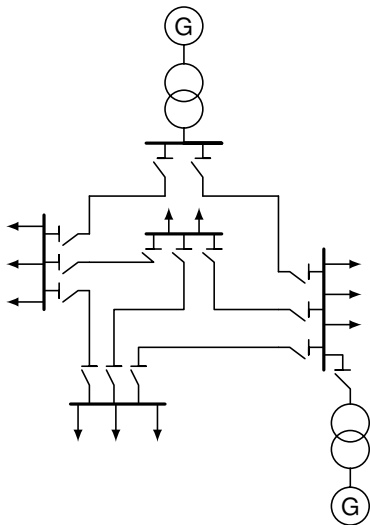

- Multiple (redundant) conductors
- Used in areas with high load density
- Often underground cables used
- Advantages
 - Very reliable (N-1 secure)
 - Outage/failure of one line
 - Even voltage profile
 - Low losses
- Disadvantages
 - Network analysis and design more complex
 - Too large meshed networks can be difficult to re-start after blackout

- Substations connect different voltage levels in a power system
- Main tasks
 - Nodes of power network that connect different voltage levels with each other via power transformers
 - Switching station at which different lines leaving or entering substations can be connected and disconnected
 - Measuring, monitoring and control of local variables (e.g., voltage, current, protection, meters)
 - Separation of distribution from transmission network



©David Neale

- System monitoring and operation takes place in *control centers*
- Depending on size of network, there may be one or more control centers
- Control centers obtain data from several measuring points (e.g., substations) in network via supervisory-and-data-aquisition (SCADA) system

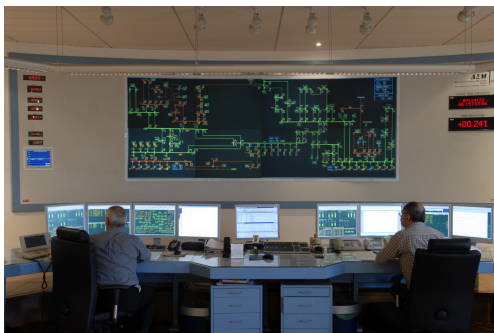

Source: <https://www.dsm.org.cy/>

- For proper functioning of many appliances, it is essential that not only required amount of power is supplied, but also that it is provided with a certain *power quality*
- Power quality is measure for "fitness" of electrical power delivered to consumers
- It comprises the following criteria
 - Continuity of service
 - Variation in voltage magnitude
 - Frequency stability
 - Unbalances and harmonic content
- Control and compensation equipment ensures that (usually) deviations from nominal voltage amplitude and frequency remain within $\pm 10\%$ of their respective nominal values at customer's point of connection

- 1 EEN320 - course description
- 2 Electric energy
- 3 Generation of electric energy
- 4 Transmission and distribution of electric energy
- 5 Consumption of electric energy**

Typical load sectors

- Industrial
- Commercial
 - Offices
 - Schools
 - Shops etc.
- Residential (domestic)
 - Refrigerators
 - Freezers
 - Heating
 - Air condition etc.

5 Cyprus winter 2007 representative daily load curve

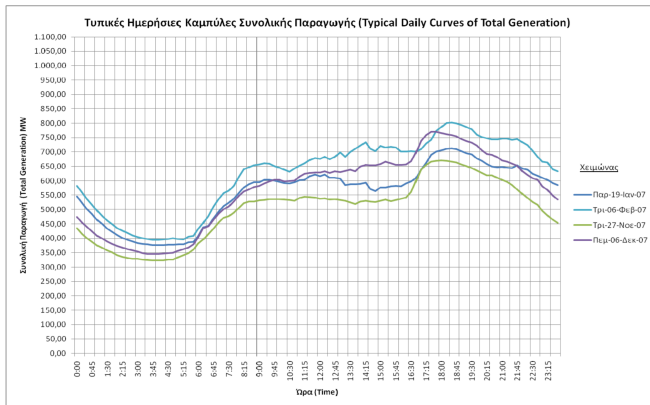

Source: <https://www.dsm.org.cy/>

- Base load: approx. 350 MW / Daily fluctuation: approx. 350 MW (December curve)
- Peak occurs in the evening (18:30), high lighting and heating demand

5 Cyprus summer 2007 representative daily load curve

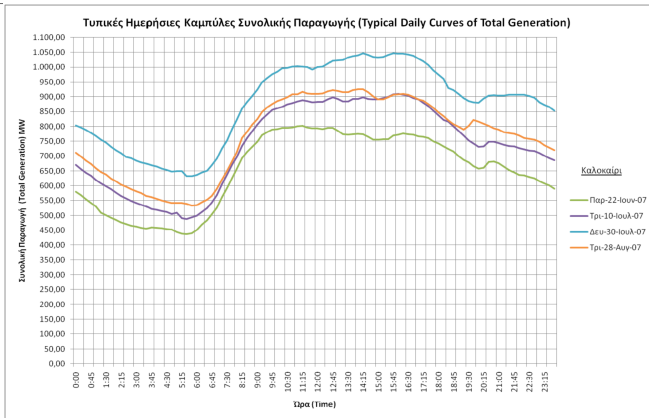

- Base load: approx. 600 MW / Daily fluctuation: approx. 400 MW (July curve)
- Peak occurs at noon, high air-conditioning demand
- On average 40% higher demand in summer

Source: <https://www.dsm.org.cy/>

5 Comparison of daily load curves

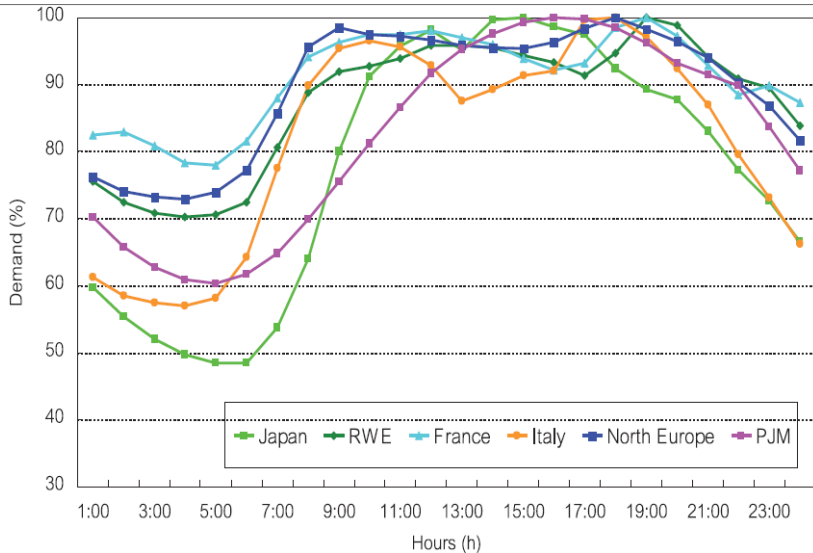

Source: IEC, Electrical Energy Storage

On demand-side...

- Load demand exhibits long-term (e.g. seasonal) and short-term variations (e.g. daily)
- Irregular events: extreme weather, special events (e.g. World Cup final)
- Exact load demand never known beforehand

On generation- and infrastructure-side...

- Up to today, electric energy can not be stored in significant quantities (e.g. GWh)
- Electric equipment (generation plants, substations, power lines, ...) is often used for decades
- Planning, construction and commissioning of new equipment also often takes decades
- Investment costs are fairly high
- Starting-up large power stations can take up to several days

- (Most) Energy has to be produced at the moment it is demanded
- Need to estimate load demand in advance (load forecast)
- Need to plan power generation based on demand forecast
- Need of real-time adjustments (controls)
- Installation of new equipment requires careful technical and economic planning

- Electric power systems highly complex and nonlinear
 - Electric power can *not* be stored
- Generation needs to match load in real time!
- Key infrastructure
 - Power generators
 - Loads
 - Transmission network
 - Distribution network
 - Substations with power transformers to connect networks at different voltage levels
 - System operator